

T60+

BayLan Compact Timezone Fingerprint Time Attendance & Access Control Reader Ethernet Interface

BayLan T60 is professional fingerprint access control system which fully integrates LCD keypad, optical fingerprint sensor, card reader and professional access control components. The very compact design makes it suitable for installation on door frame. T60 can be used for both simple access control and separate type secure access control. In addition, T60 has Wiegand input, alarm output and door bell output for a complete access control solution. Mini USB, RS485 and TCP/IP communication is available for all kinds of installation sites. With ID, optional Mifare and HID card reader is specially designed for the existing card users and higher security level. T60 can work perfectly to meet different demand for access control.



FEATURES

- World leading brand. Korean industrial design. Elegant white LCD
- New generation fully sealed, waterproof and dustproof fingerprint sensor
- BioNano core fingerprint algorithm for T&A and Access Control, high performance and reliability.
- Professional fingerprint strengthen membrane. Improved performance to dry or wet finger. Easy maintenance. 360 degree identification
- Stand-alone without being connected with computer. Standard fingerprint capacity 2000. Standard record capacity 50000
- Multiple identification method: Fingerprint, ID + Password, ID + Fingerprint, ID+ Card, Card
- With ID, optional Mifare or HID card reader
- Standard Mini USB, RS232/485 and TCP/IP communication
- Can directly drive the electric lock to open the door. Optional SC021 or SC822 access controller for separate type secure access control
- Tamper alarm output to connect with alarm equipment outside and output the alarm card No. to controller by wiegand 26
- Support time zone access control and realtime data monitor, easy-to-use and user-friendly software
- Wall mounted, combine 2-in-1 function for time attendance and access control

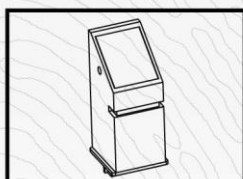

Advanced waterproof, dustproof, scratchproof fingerprint sensor

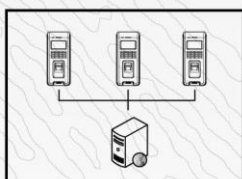

Server identification

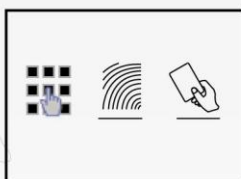

Combination of password, fingerprint and card

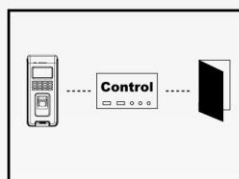

Separate type secure access control

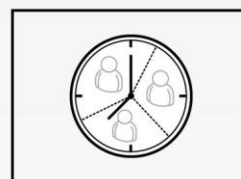

Time zone access control

PARAMETER

Sensor	Optical sensor
LCD	White LCD
Identification Method	FP, ID+PW, ID+FP, ID+Card, Card
Identification Time	≤1 second
Register Method	Fingerprint, password, ID/Mifare/HID Card (optional)
Fingerprint Capacity	2000
Record Capacity	50000
FRR	0.001%
FAR	0.00001%
Standard Port	Wiegand26, alarm output, bell output, DC12V/2A electric drive
Optional Port	Mini USB,RS485,TCP/IP

Working Current	<200mA
Sleeping Current	<50uA
ESD Tolerance	>15000V
Power	DC12V
Temperature/ Humidity	-10°C-60°C / 20%-80%
Size	200(w)*90 (h)*35(d)mm
Color	Black (customizable)
Scan Area	22mm*18mm
Resolution	500DPI
Casing material	ABS industrial plastic

Appearance drawing

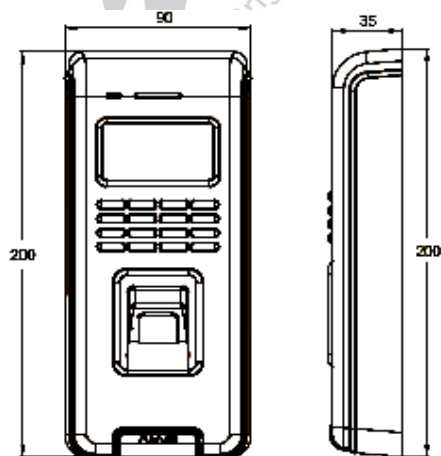

Front View

Side View

Network topology illustration

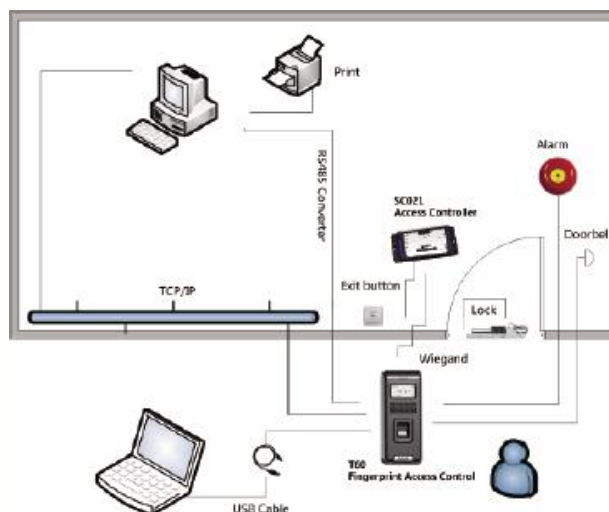

Single door separate type access control Solution

Specifications are subject to change without prior notice with advancement in technology.